



INSTYTUT TECHNIKI BUDOWLANEJ
PL 00-611 WARSZAWA
ul. Filtrowa 1
tel.: (+48 22) 825-04-71
(+48 22) 825-76-55
fax: (+48 22) 825-52-86
www.itb.pl



European Technical Assessment

**ETA-17/0680
of 02/08/2017**

General Part

Technical Assessment Body issuing the European Technical Assessment

Instytut Techniki Budowlanej

Trade name of the construction product

Injection system 680 ANKER KLEBER

Product family to which the construction product belongs

Post-installed rebar connections with 680 ANKER KLEBER mortar

Manufacturer

Ramsauer GmbH & Co KG
Aigen 24
5351 Voglhub, Austria

Manufacturing plant

Ramsauer – Manufacturing plant 1

This European Technical Assessment contains

22 pages including 3 Annexes which form an integral part of this Assessment

This European Technical Assessment is issued in accordance with regulation (EU) No 305/2011, on the basis of

Guideline for European Technical Approval ETAG 001, Edition April 2013 “Metal anchors for use in concrete – Part 1: Anchors in general and Part 5: Bonded anchors”, used as European Assessment Document (EAD)

This European Technical Assessment is issued by the Technical Assessment Body in its official language. Translations of this European Technical Assessment in other languages shall fully correspond to the original issued document and should be identified as such.

Communication of this European Technical Assessment, including transmission by electronic means, shall be in full. However, partial reproduction may be made, with the written consent of the issuing Technical Assessment Body. Any partial reproduction has to be identified as such.

Specific Part

1 Technical description of the product

The subject of this assessment are the post-installed connections, by anchoring or overlap connection joint of steel reinforcing bars (rebars) in existing structures made of normal weight concrete, using injection mortar 680 ANKER KLEBER in accordance with the regulations for reinforced concrete construction.

Reinforcing bars made of steel with diameter from 8 to 32 mm and 680 ANKER KLEBER injection mortars are used for the post-installed rebar connections. The steel element is placed into a drilled hole previously filled with a injection mortar and is anchored by the bond between embedded element, injection mortar and concrete.

An illustration and the description of the products are given in Annex A1 to A4.

2 Specification of the intended use in accordance with the applicable European Assessment Document (EAD)

The performances given in Section 3 are only valid if the post-installed connections are used in compliance with the specifications and conditions given in Annex B1 to B11.

The performances given in this European Technical Assessment are based on an assumed working life of the anchor of 50 years. The indications given on the working life cannot be interpreted as a guarantee given by the producer or the Technical Assessment Body, but are to be regarded only as a means for choosing the right products in relation to the expected economically reasonable working life of the works.

3 Performance of the product and references to the methods used for its assessment

3.1 Performance of the product

3.1.1 Mechanical resistance and stability (BWR 1)

The essential characteristic are detailed in the Annex C1 to C3.

3.1.2 Safety in case of fire (BWR 2)

No performance assessed.

3.1.3 Hygiene, health and the environment (BWR 3)

Regarding dangerous substances there may be requirements applicable to the products falling within its scope (e.g. transposed European legislation and national laws, regulations and administrative provisions). In order to meet the provisions of the Construction Products Regulation, these requirements need also to be complied with, when and where they apply.

3.1.4 Safety and accessibility in use (BWR 4)

For basic requirement Safety in use the same criteria are valid as for Basic Requirement Mechanical resistance and stability (BR 1).

3.1.5 Sustainable use of natural resources (BWR 7)

No performance assessed.

3.2 Methods used for the assessment

The assessment of fitness of the post-installed rebar connections for declared intended use in relation to the requirements for mechanical resistance and stability and safety in use in the sense of the Basic Requirements 1 and 4 has been made in accordance with the ETAG 001 "Metal anchors for use in concrete", Part 1: "Anchors in general" and Part 5: "Bonded anchors" and EOTA Technical Report TR 023 "Assessment of post-installed rebar connections".

4 Assessment and verification of constancy of performance (AVCP) system applied, with reference to its legal base

According to Decision 96/582/EC of the European Commission the system of assessment and verification of constancy of performance (see Annex V to Regulation (EU) No 305/2011) given in the following table applies.

Product	Intended use	Level or class	System
Metal anchors for use in concrete	For fixing and/or supporting to concrete structural elements (which contributes to the stability of the works) or heavy units	–	1

5 Technical details necessary for the implementation of the AVCP system, as provided for in the applicable European Assessment Document (EAD)

Technical details necessary for the implementation of the AVCP system are laid down in the control plan deposited at Instytut Techniki Budowlanej.

For type testing the results of the tests performed as part of the assessment for the European Technical Assessment shall be used unless there are changes in the production line or plant. In such cases the necessary type testing has to be agreed between Instytut Techniki Budowlanej and the notified body.

Issued in Warsaw on 02/08/2017 by Instytut Techniki Budowlanej

Krzysztof Kuczyński, PhD
Deputy Director of ITB

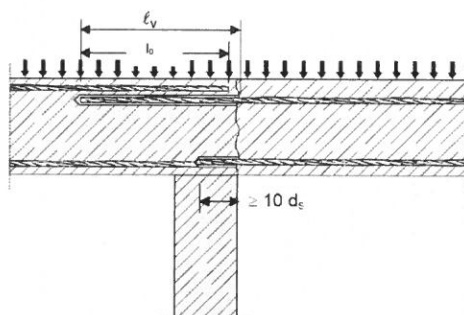

Figure 1: Overlap joint for rebar connections of slabs and beams

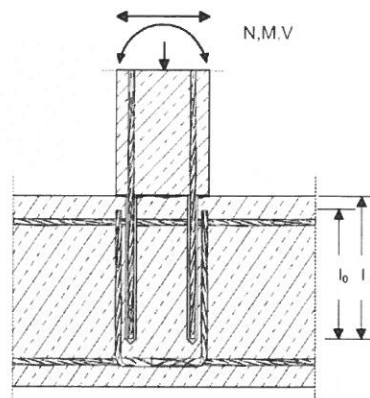

Figure 2: Overlap joint at a foundation of a column or wall where the rebars are stressed in tension

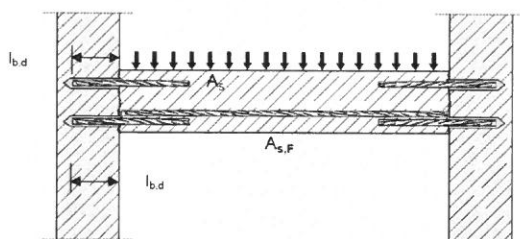

Figure 3: End anchoring of slabs or beams, designed as simply supported

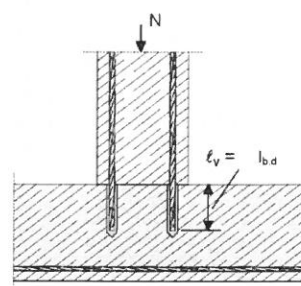

Figure 4: Rebar connection for components stressed primarily in compression. The rebars are stressed in compression

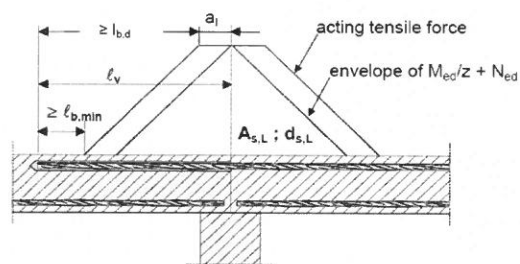

Figure 5: Anchoring of reinforcement to cover the line of acting tensile force

Note to Figure 1 to 5:

In the Figures no transverse reinforcement is plotted, the transverse reinforcement as required by EC 2 shall be present. The shear transfer between old and new concrete shall be designed according to EC 2.

**Injection system 680 ANKER KLEBER
for rebar connections**

Use of the product

Annex A1
of European
Technical Assessment
ETA-17/0680

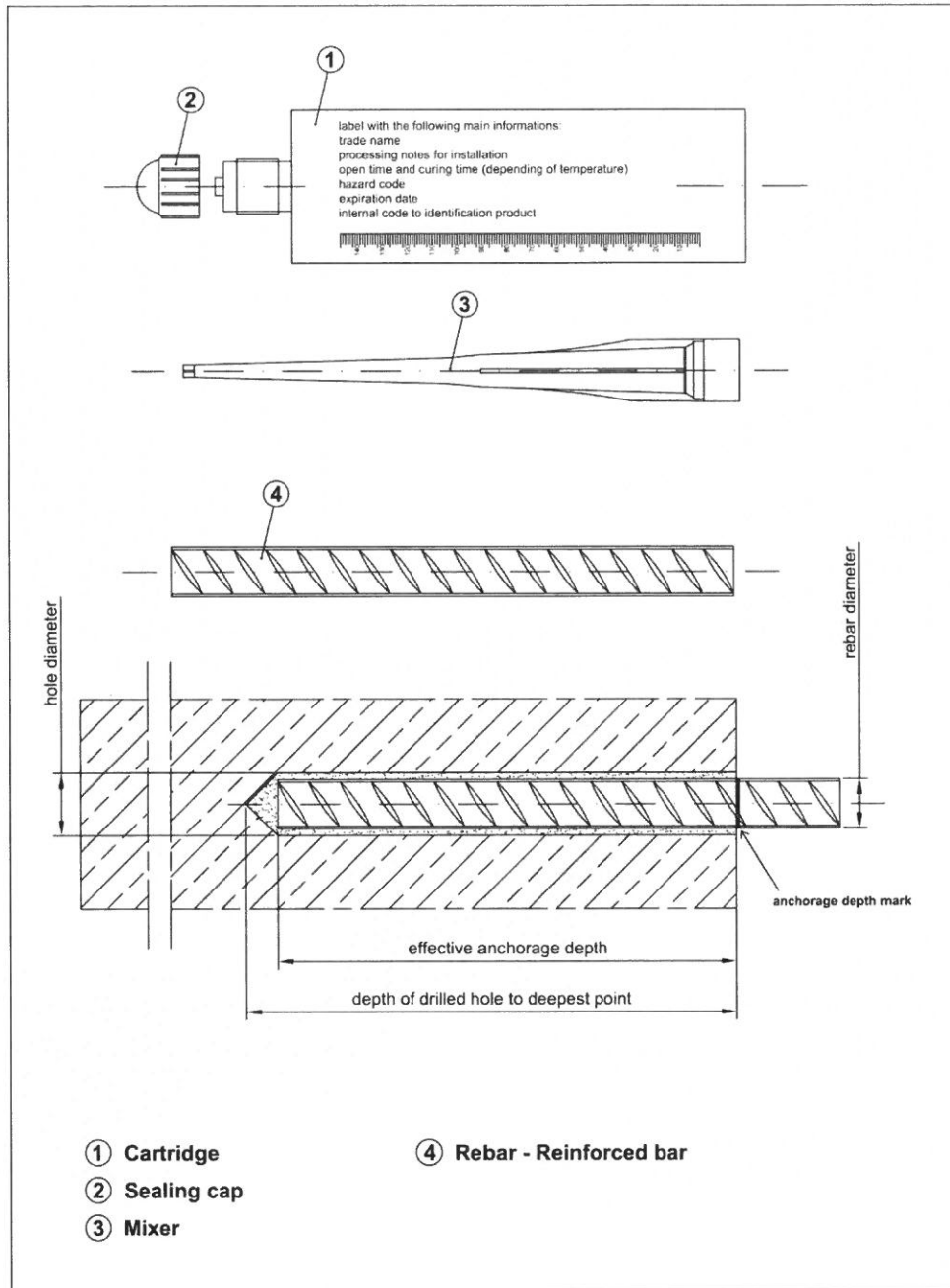

**Injection system 680 ANKER KLEBER
 for rebar connections**

Product description

Annex A2
 of European
 Technical Assessment
 ETA-17/0680

Table A1: Rebars

Designation	Rebars
Rebars according to EN 1992-1-1, Annex C, Table C.1 and C.2N	Bars and de-coiled rods Class B or C Minimum relative rib area, $f_{R,min}$, according to EN 1992-1-1 The rib height h : $h \leq 0,07 \cdot \varnothing$

Table A2: Injection mortars

Designation	Composition
680 ANKER KLEBER (two component injection mortars)	Additive: quartz Bonding agent: vinyl ester resin styrene free Hardener: dibenzoyl peroxide

Injection system 680 ANKER KLEBER for rebar connections	Annex A3 of European Technical Assessment ETA-17/0680
Materials	

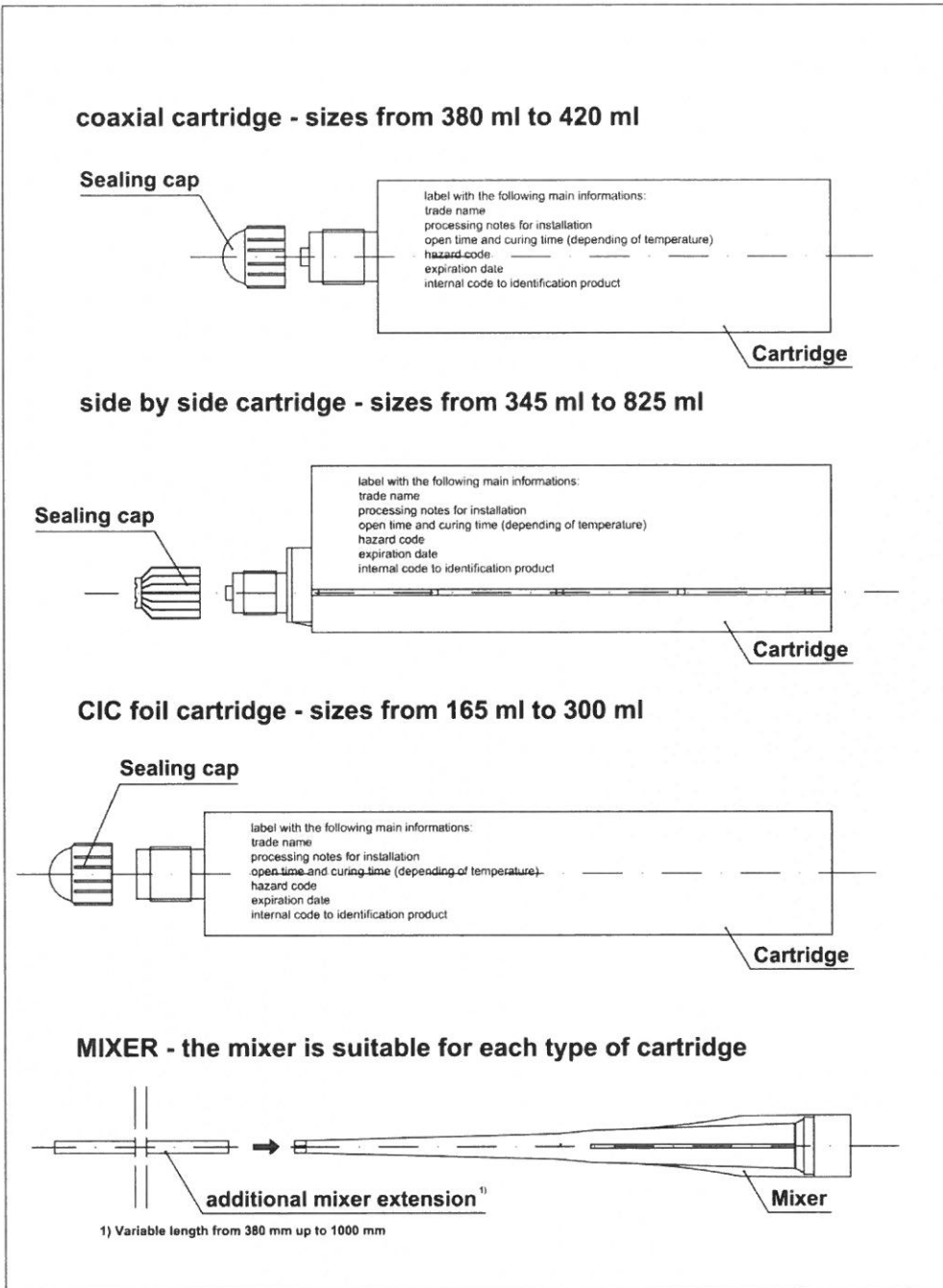

**Injection system 680 ANKER KLEBER
for rebar connections**

Cartridge types and sizes

Annex A4
of European
Technical Assessment
ETA-17/0680

SPECIFICATION OF INTENDED USE

Anchorage subject to:

Static and quasi-static loads.

Base material:

- Reinforced or unreinforced normal weight concrete of strength class C12/15 at minimum to C50/60 at maximum according to EN 206-1.
- Maximum chloride content of 0,20% (Cl 0,20) related to the cement content according to EN 206-1.
- Non-carbonated concrete.

Note: In case of a carbonated surface of the existing concrete structure the carbonate layer shall be removed in the area of the post-installed rebar connection with a diameter of $d_s + 60$ mm prior to the installation of the new rebar. The depth of concrete to be removed shall correspond to at least the minimum concrete cover according to EN 1992-1-1.

The above may be neglected if building components are new and not carbonated and if building components are in dry conditions.

Temperature range:

The products may be used in the following temperature range:

- -40°C to +80°C (max. short term temperature +80°C and max. long term temperature +50°C).

Use conditions (Environmental conditions):

- Structures subject to dry internal conditions.
- Structures subject to external atmospheric exposure including industrial and marine environment.
- Structures subject to permanently damp internal conditions if no particular aggressive conditions exist.

Note: Particular aggressive conditions are e.g. permanent, alternating immersion in seawater or the splash zone of seawater, chloride atmosphere of indoor swimming pools or atmosphere with extreme chemical pollution (e.g. in desulphurization plants or road tunnels where de-icing materials are used).

Design:

- Anchorages are designed under the responsibility of an engineer experienced in anchorages and concrete work.
- Verifiable calculation notes and drawings are prepared taking into account of the forces to be transmitted.
- Design according to EN 1992-1-1 and Annex B2.
- The actual position of the reinforcement in the existing structure shall be determined on the basis of the construction documentation and taken into account when designing.

Installation:

- Dry or wet concrete (use category 1).
- It must not be installed in flooded holes.
- Overhead installation is permissible.
- Hole drilling by hammer drill.
- Installation of the post-installed rebars shall be done only by suitable trained installer and under supervision on the site.
- Check the position of the existing rebars (if the position of existing rebars in not known it shall be determined using a rebar detector suitable for this purpose as well as on the basis of the construction documentation and then marked on the building component for the overlap joint).

<p>Injection system 680 ANKER KLEBER for rebar connections</p>	<p>Annex B1 of European Technical Assessment ETA-17/0680</p>
<p>Intended use. Specification</p>	

General design rules of construction for post-installed rebars

- Only tension forces in the axis of the rebar may be transmitted.
- The transfer of shear forces between new concrete and existing structure shall be designed additionally according to EN 1992-1-1.
- The joints for concreting must be roughened to at least such an extent that aggregate protrude.

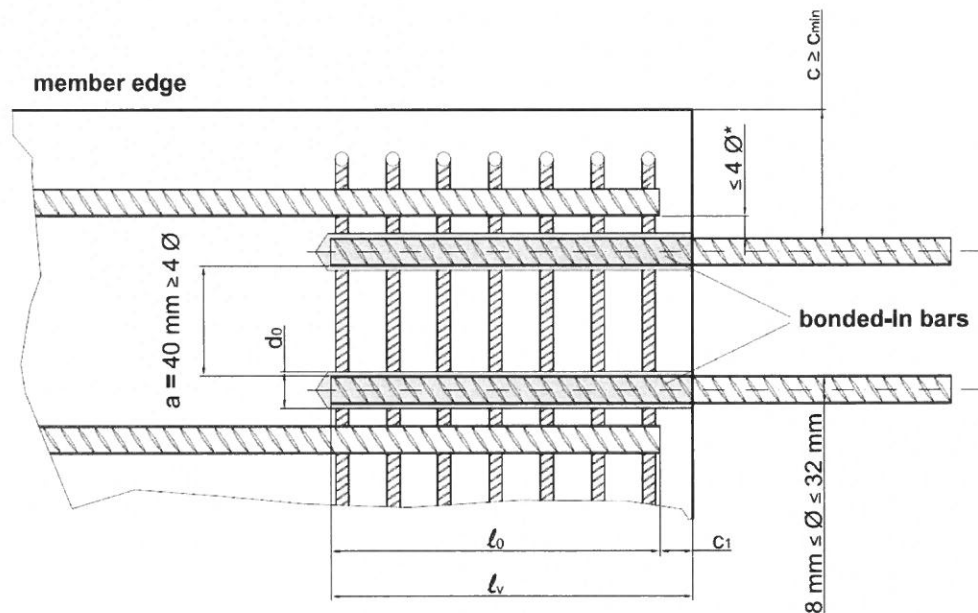

* If the clear distance between overlapping rebars is greater than $4 \cdot \varnothing$ the overlap length shall be enlarged by the difference between the clear distance and $4 \cdot \varnothing$.

l_0 – lap length acc. to EN 1992-1-1, clause 8.7.3

l_v – effective embedment depth; $l_v \geq l_0 + c_1$

c – concrete cover of post-installed rebar

c_{min} – minimum concrete cover acc. to Annex B3 and EN 1992-1-1, clause 4.4.1.2.

c_1 – concrete cover at end-face of existing rebar

d_0 – nominal drill bit diameter acc. to Annex B3

\varnothing – rebar diameter (d_s)

**Injection system 680 ANKER KLEBER
for rebar connections**

Intended use. General construction rules for post-installed rebars

Annex B2
of European
Technical Assessment
ETA-17/0680

Table B1: Installation data – hammer drilling

Rebar diameter [mm]	Ø8	Ø10	Ø12	Ø14	Ø16	Ø20	Ø25	Ø28	Ø32
Drill bit diameter [mm]	12	14	16	18	20	25	30	35	40
Brush diameter [mm]	14	16	18	20	22	27	32	37	42
Minimum anchorage length $l_{b,min}$ [mm]	115	145	170	200	230	285	355	400	455
Minimum anchorage length $l_{o,min}$ - overlap joint [mm]	200	200	200	210	240	300	375	420	480
Maximum embedment depth $l_{v,max}$ [mm]	400	500	600	700	800	1000	1000	1000	1000

Note: $l_{b,min}$ and $l_{o,min}$ according to EN 1992-1-1 (8.6) and (8.11) with: yield stress for rebar 500 N/mm²; $\gamma_M = 1,15$; $\alpha_6 = 1,0$; concrete C20/25 and $f_{bd} = 2,30$ N/mm² (good bond conditions)

Minimum concrete cover (see Annex B2):

$$c_{min} = 30 \text{ mm} + 0,06 \cdot l_v \geq 2 \cdot \varnothing \text{ for } \varnothing < 25 \text{ mm}$$

$$c_{min} = 40 \text{ mm} + 0,06 \cdot l_v \geq 2 \cdot \varnothing \text{ for } \varnothing \geq 25 \text{ mm}$$

The minimum concrete cover according to EN 1992-1-1 shall be observed.

Minimum clear spacing between two post-installed rebars:

$$a = 40 \text{ mm} \geq 4 \cdot \varnothing$$

**Injection system 680 ANKER KLEBER
for rebar connections**

Installation data

Annex B3
of European
Technical Assessment
ETA-17/0680

Table B2: Processing time and minimum curing time

680 ANKER KLEBER (standard version)		
Concrete temperature [C°]	Processing time [min.]	Minimum curing time¹⁾[min.]
-5	65	780
0	45	420
+5	25	90
+10	16	60
+15	11,5	45
+20	7,5	40
+25	5	35
+30	3	30
+35	2	25
+40	1	20

¹⁾ The minimum time from the end of the mixing to the time when the rebar may be loaded. Minimum resin temperature for installation +5°C. Maximum resin temperature for installation +30°C. For wet condition the curing time must be double.

**Injection system 680 ANKER KLEBER
for rebar connections**

Processing time and curing time

Annex B4
of European
Technical Assessment
ETA-17/0680

Manual Blower pump: nominal dimensions

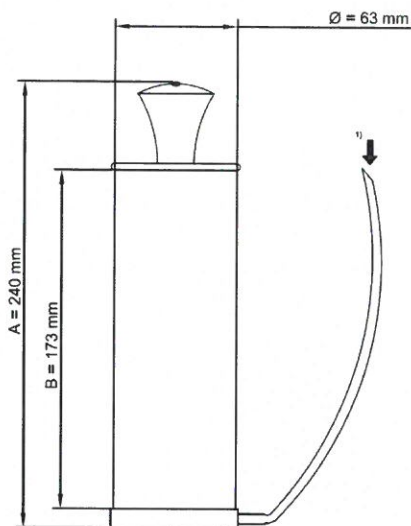

It is possible to use the mixer extensor with the manual blower pump.

However It is possible to blow the hole using the mechanical air system (compressed air) also with the mixer estension

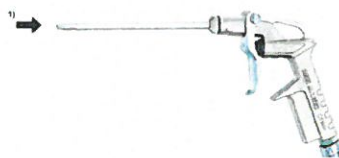

Suitable min pressure 6 bar at 6 m³/h
Oil-free compressed air
Recommended air gun with an orifice opening of minimum 3.5 mm in diameter

1) Position to insert the mixer extension

Mixer extension (from 380 mm to 1000 mm) with nominal diameter 8 mm

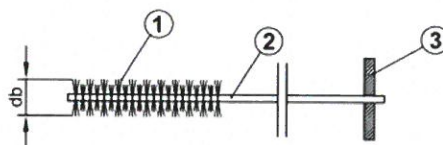

- ① Steel bristles
- ② Steel stem
- ③ Wood handle

Table B3: Standard brush details (manual brush)

Rebar diameter [mm]			Ø8	Ø10	Ø12	Ø14	Ø16
d ₀	Nominal drill hole	[mm]	12	14	16	18	20
d _b	Brush diameter	[mm]	14	16	18	20	22

**Injection system 680 ANKER KLEBER
for rebar connections**

Cleaning tools (1)

Annex B5
of European
Technical Assessment
ETA-17/0680

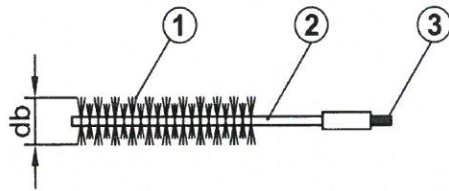

- ① Steel bristles
- ② Steel stem
- ③ Threaded connection for drilling tool extension
- ④ Extension special brush
- ⑤ Drilling tool connection (SDS connection)

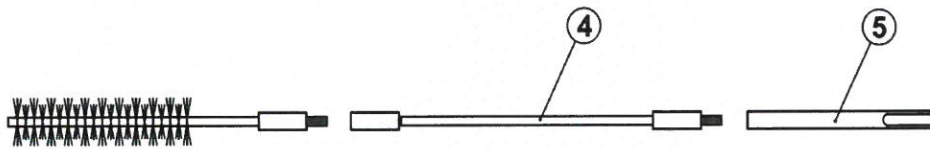

Table B4: Special brush details (mechanical brush)

Rebar diameter [mm]			Ø8	Ø10	Ø12	Ø14	Ø16	Ø20	Ø25	Ø28	Ø32
d₀	Nominal drill hole	[mm]	12	14	16	18	20	25	30	35	40
d_b	Brush diameter	[mm]	14	16	18	20	22	27	32	37	42

**Injection system 680 ANKER KLEBER
for rebar connections**

Cleaning tools (2)

Annex B6
of European
Technical Assessment
ETA-17/0680

Use the mixer extension (assembled on the standard mixer) for the injection up to 300 mm if necessary.

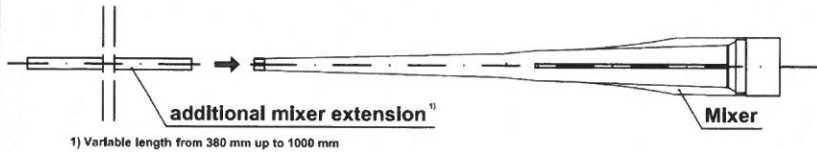

Use this system for special conditions.

Tools for installation in special condition

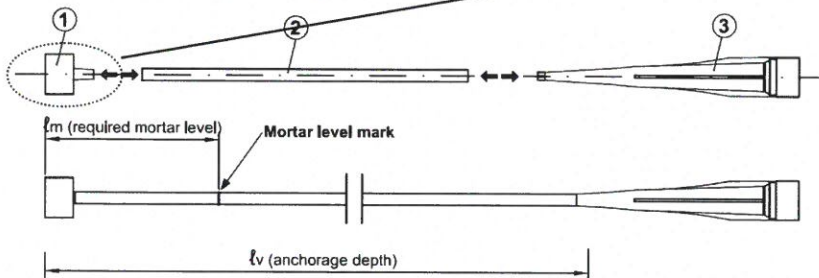

- ① Injection plug (nominal diameter according to the nominal diameter of drilled hole)
- ② Special mixer extension (variable length with external diameter 10 mm)
Mark the required mortar level ℓ_m and embedment depth ℓ_v with tape or marker on the injection extension. Quick estimation: $\ell_m = 1/3 \cdot \ell_v$
Continue Injection until the mortar level mark ℓ_m becomes visible.
- ③ Mixer (suitable for all size of cartridge)

These tools allow the application in special conditions:
- Installation with anchorage depth greater than 300 mm;
- overhead installation.

For these applications is recommended the use of the Injection pneumatic pump.

System assembled

- ① Injection plug
- ② Special mixer extension
- ③ Mixer
- ④ cartridge
- ⑤ Sample of Injection pneumatic pump

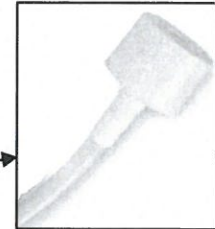
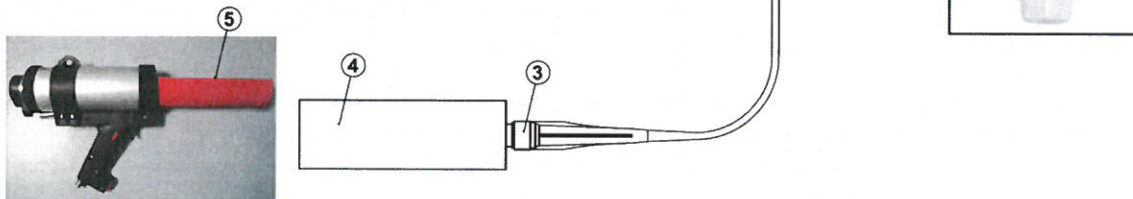

Insert the special mixer extension in the inner diameter of the injection plug up to reach the top of the plug

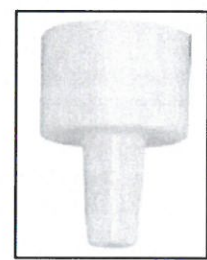
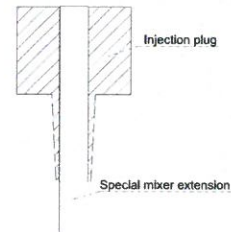







**Injection system 680 ANKER KLEBER
for rebar connections**

Tools for installation (1)



Annex B7
of European
Technical Assessment
ETA-17/0680

Table B5: Mortar injection pumps

Pumps (injection guns)	Cartridges	Clean hole tools	Maximum depth of the drill hole
 <i>Manual</i>	825 ml	Blower pump or compressed air and standard brush or special brush	300 mm
 <i>Manual</i>	400 ml 380 ml	Blower pump or compressed air and standard brush or special brush	300 mm
 <i>Manual</i>	345 ml 300 ml 165 ml	Blower pump or compressed air and standard brush or special brush	300 mm
 <i>Manual</i>	300 ml 165 ml	Blower pump or compressed air and standard brush or special brush	300 mm
 <i>Pneumatic</i>	825 ml	Compressed air and special brush	300 mm to 1000 mm*
 <i>Pneumatic</i>	400 ml 380 ml	Compressed air and special brush	300 mm to 1000 mm*

* Note: use the mixer extension described in Annex B7 for the injection of the mortar

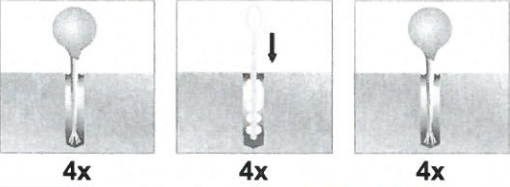
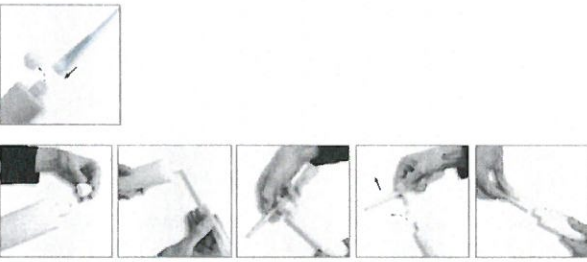
Injection system 680 ANKER KLEBER for rebar connections	Annex B8 of European Technical Assessment ETA-17/0680
Tools for installation (2)	

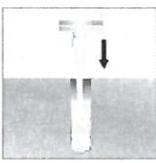
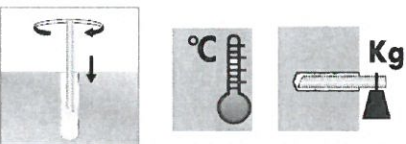
1		<p>Drill the hole with the correct diameter and depth using a rotary percussive machine (hammer drill). Check the perpendicularity of the hole during the drilling operation.</p>
2		<p>Clean the hole from the drilling dust: the hole shall be cleaned by at least four blowing operations, by at least four brushing operations followed again by at least four blowing operations; before brushing clean the brush and check (according to Annex B5 and B6) if the brush diameter is sufficient. For the blower tools see Annex B5.</p>
3		<p>For coaxial and side by side cartridge unscrew the front cup, screw on the mixer and insert the cartridge in the injection gun. For the CIC cartridges, unscrew the front cup, pull-out the steel closing clip according to the following operations:</p> <ul style="list-style-type: none"> - insert the mixer in the eye of the plastic extractor, - pull the extractor to unhook the steel closing clip of the foil. After that, screw on the mixer and insert the cartridge in the injection gun. Proper extrusion system according to Annex B8.
4		<p>Before starting to use the cartridge, eject a first part of the product, being sure that the two components are completely mixed. The complete mixing is reached only after that the product, obtained by mixing the two component, comes out from the mixer with an uniform color.</p>
5	 <p>if necessary use a mixer extension for the injection (see Annex B5)</p>	<p>Fill the drilled hole uniformly starting from the drilled hole bottom, in order to avoid entrapped air; remove the mixer slowly bit by bit during pressing-out; filling the drill hole with a quantity of the injection mortar corresponding to 2/3 of the drill hole depth.</p>
6		<p>Insert immediately the rebar, marked according to Annex A2, slowly and with a slight twisting motion, removing excess of injection mortar around the rebar. Observe the curing time according to Annex B4.</p>
<p>Injection system 680 ANKER KLEBER for rebar connections</p>		<p>Annex B9 of European Technical Assessment ETA-17/0680</p>
<p>Installation instruction up to 300 mm depth</p>		

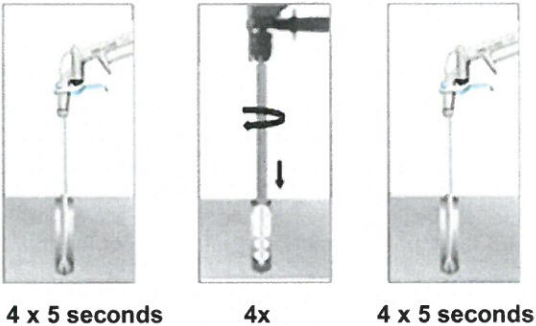
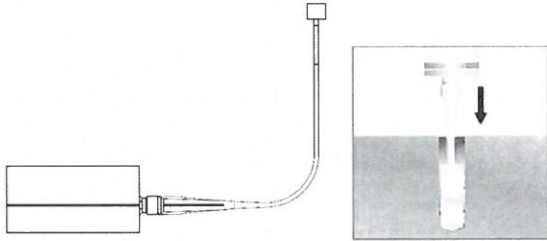
1	See point 1 Annex B9	
2	 <p>4 x 5 seconds 4x 4 x 5 seconds</p> <p>ATTENTION: compressed air free oil</p>	<p>Clean the hole from the drilling dust: the hole shall be cleaned by at least four blowing operations, by at least four brushing operations followed again by at least four blowing operations; before brushing clean the brush and check (according to Annex B5 and B6) if the brush diameter is sufficient. For the blower tools see Annex B5.</p>
3	See point 3 Annex B9	
4	See point 4 Annex B9	
5		<p>Before starting the injection, assemble the system according to Annex B7. After that, fill the drilled hole uniformly from the drilled hole bottom, in order to avoid entrapment of the air; remove the special mixer extension with injection plug slowly bit by bit during pressing-out; filling the drill hole with a quantity of the injection mortar corresponding to 2/3 of the drill hole depth.</p> <p>Procedure for overhead installation are detailed in Annex B11.</p>
6	See point 6 Annex B9	
<p>Injection system 680 ANKER KLEBER for rebar connections</p>		<p>Annex B10</p>
<p>Installation instruction up to 1000 mm depth</p>		<p>of European Technical Assessment ETA-17/0680</p>

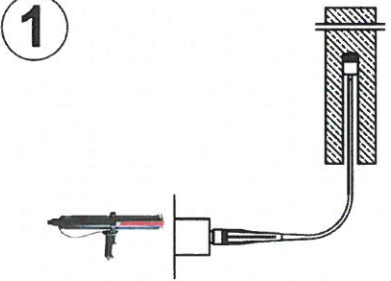
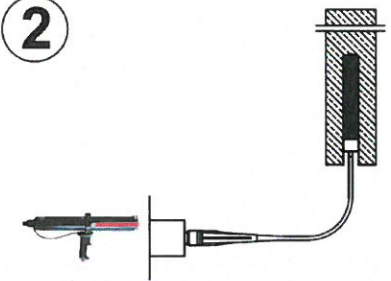
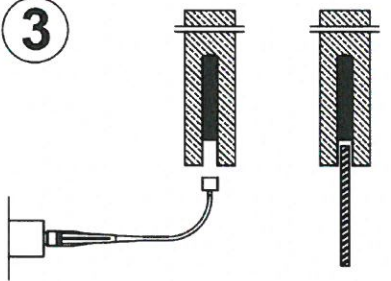
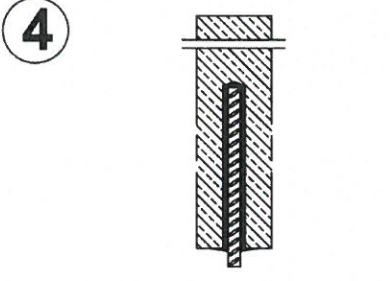
<p>1</p> 	<p>1 - Start injection</p> <p>Inject from the bottom of the hole. Maintain this position during the injection phase.</p>
<p>2</p> 	<p>2 - Injection phase</p> <p>Inject the product about 2/3 of the hole depth. During the injection maintain this position to assure the correct installation</p>
<p>3</p> 	<p>3 - End injection</p> <p>Remove the Injection plug. Insert immediately the rebar (turn the rebar during the Insertion).</p>
<p>4</p> 	<p>4 - End installation</p> <p>To avoid the slipping of the rebar during the open time of the product (due to the rebar own weight) use a temporary interlocking element (for ex. wedge of wood)</p>

**Injection system 680 ANKER KLEBER
for rebar connections**

Overhead installation instruction

Annex B11
of European
Technical Assessment
ETA-17/0680

Table C1. Design values of the ultimate bond resistance f_{bd} according to EN 1992-1-1 for hammer drilling

Rebar diameter [mm]	Ultimate bond resistance f_{bd} ¹ [N/mm ²]								
	C12/15	C16/20	20/25	C25/30	C30/37	C35/45	C40/50	C45/55	C50/60
Ø8	1,60	2,00	2,30	2,70	3,00	3,40	3,70	4,00	4,30
Ø10	1,60	2,00	2,30	2,70	3,00	3,40	3,70	4,00	4,30
Ø12	1,60	2,00	2,30	2,70	3,00	3,40	3,70	4,00	4,30
Ø14	1,60	2,00	2,30	2,70	3,00	3,40	3,70	4,00	4,30
Ø16	1,60	2,00	2,30	2,70	3,00	3,40	3,70	4,00	4,00
Ø20	1,60	2,00	2,30	2,70	3,00	3,40	3,70	4,00	4,00
Ø25	1,60	2,00	2,30	2,70	3,00	3,40	3,70	3,70	3,70
Ø28	1,60	2,00	2,30	2,70	3,00	3,40	3,40	3,40	3,40
Ø32	1,60	2,00	2,30	2,70	2,70	2,70	2,70	2,70	2,70

¹ The values given are valid for good bond condition according to EN 1992-1-1.
For all other bond conditions multiply the value by 0,7.

**Injection system 680 ANKER KLEBER
for rebar connections**

Design values of the ultimate bond resistance

Annex C1
of European
Technical Assessment
ETA-17/0680

Values for pre-calculation of anchoring rebars connections							
Examples for anchorage length ¹⁾ ($f_{y,k} = 500 \text{ N/mm}^2$; concrete C20/25; $f_{bd} = 2,3 \text{ N/mm}^2$)							
Rebar \varnothing	Tensile load B500	$\alpha_1 = \alpha_2 = \alpha_3 = \alpha_4 = \alpha_5 = 1,0$			$\alpha_1 = \alpha_3 = \alpha_4 = 1,0$ and α_2 or $\alpha_5 = 0,7$		
		Anchorage length $l_{bd}^{(1)}$	Tension load	Mortar volume V	Anchorage length $l_{bd}^{(1)}$	Tension load	Mortar volume V
[mm]	[kN]	[mm]	[kN]	[ml]	[mm]	[kN]	[ml]
8	21,85	115	6,65	8,50	115	9,50	8,50
		180	10,40	13,31	180	14,86	13,31
		250	14,45	18,48	200	16,52	14,78
		320	18,50	23,65	220	18,17	16,26
		378	21,85	27,95	265	21,85	19,56
10	34,15	145	10,48	12,86	145	14,97	12,86
		230	16,62	20,40	230	23,74	20,40
		310	22,40	27,50	260	26,84	23,06
		390	28,18	34,59	290	29,93	25,72
		473	34,15	41,92	331	34,15	29,34
12	49,17	170	14,74	17,59	170	21,06	17,59
		270	23,41	27,94	270	33,44	27,94
		370	32,08	38,29	300	37,16	31,05
		470	40,75	48,64	330	40,88	34,15
		567	49,17	58,69	397	49,17	41,08
14	66,93	200	20,23	23,65	200	28,90	23,65
		320	32,37	37,85	320	46,24	37,85
		440	44,51	52,04	360	52,02	42,58
		560	56,65	66,23	400	57,81	47,31
		662	66,93	78,25	463	66,93	54,78
16	87,42	230	26,59	30,60	230	37,99	30,60
		360	41,62	47,90	360	59,46	47,90
		490	56,65	65,20	400	66,06	53,22
		620	71,68	82,49	440	72,67	58,54
		756	87,42	100,61	529	87,42	70,43
20	136,59	285	41,19	59,25	285	58,84	59,25
		450	65,03	93,55	450	92,90	93,55
		620	89,60	128,90	500	103,22	103,95
		790	114,17	164,24	550	113,55	114,34
		945	136,59	196,50	662	136,59	137,55
25	213,42	355	64,13	90,21	355	91,61	90,21
		520	93,93	132,13	520	134,19	132,13
		680	122,84	172,79	600	154,84	152,46
		840	151,74	213,44	650	167,74	165,16
		1000	180,64	254,10	700	180,64	177,87
28	267,72	400	80,93	162,99	400	115,61	162,99
		550	111,28	224,12	550	158,96	224,12
		700	141,62	285,24	700	202,32	285,24
		850	171,97	346,36	850	245,67	346,36
		1000	202,32	407,48	926	267,72	377,44
32	349,67	455	105,21	242,16	455	150,29	242,16
		590	136,42	314,01	500	165,16	266,11
		730	168,79	388,52	550	181,67	292,72
		870	201,16	463,03	600	198,19	319,33
		1000	231,22	532,22	700	231,22	372,56

The given values are valid for good bond condition according to EN 1992-1-1. For all other bond condition the values for tension load shall be multiplied by 0,7. The mortar volume V can be calculated using the equation: $V = l_{bd} \cdot \pi \cdot (d_0^2 - d^2) / (4 \cdot 0,85)$ with the nominal hole diameter.

**Injection system 680 ANKER KLEBER
for rebar connections**

Design values for anchoring connections

Annex C2
of European
Technical Assessment
ETA-17/0680

Values for pre-calculation of overlap joint connections							
Examples for the lap splice length ¹⁾ ($f_{y,k} = 500 \text{ N/mm}^2$; concrete C20/25; $f_{bd} = 2,3 \text{ N/mm}^2$)							
Rebar \varnothing	Tensile load B500	$\alpha_1 = \alpha_2 = \alpha_3 = \alpha_5 = \alpha_6 = 1,0$			$\alpha_1 = \alpha_3 = \alpha_6 = 1,0$ and α_2 or $\alpha_5 = 0,7$		
		Lap splice length $l_o^{1)}$	Tension load	Mortar volume V	Lap splice length $l_o^{1)}$	Tension load	Mortar volume V
[mm]	[kN]	[mm]	[kN]	[ml]	[mm]	[kN]	[ml]
8	21,85	200	11,56	14,78	200	16,52	14,78
		240	13,87	17,74	-	-	-
		280	16,19	20,70	-	-	-
		320	18,50	23,65	-	-	-
		378	21,85	27,95	-	-	-
10	34,15	200	14,45	17,74	200	20,64	17,74
		270	19,51	23,95	235	24,26	20,85
		340	24,57	30,16	270	27,87	23,95
		410	29,63	36,37	305	31,48	27,05
		473	34,15	41,92	331	34,15	29,34
12	49,17	200	17,34	20,70	200	24,77	20,70
		290	25,15	30,01	250	30,97	25,87
		380	32,95	39,33	300	37,16	31,05
		470	40,75	48,64	350	43,35	36,22
		567	49,17	58,69	397	49,17	41,08
14	66,93	210	21,24	24,84	210	30,35	24,84
		320	32,37	37,85	270	39,02	31,93
		430	43,50	50,86	330	47,69	39,03
		540	54,63	63,87	390	56,36	46,13
		662	66,93	78,25	463	66,93	54,78
16	87,42	240	27,75	31,93	240	39,64	31,93
		370	42,78	49,23	310	51,20	41,25
		500	57,81	66,53	380	62,76	50,56
		630	72,83	83,83	450	74,32	59,88
		756	87,42	100,61	529	87,42	70,43
20	136,59	300	43,35	62,37	300	61,93	62,37
		460	66,48	95,63	390	80,51	81,08
		620	89,60	128,90	480	99,09	99,79
		780	112,72	162,16	570	117,68	118,50
		945	136,59	196,50	662	136,59	137,55
25	213,42	375	67,74	95,29	375	96,77	95,29
		530	95,74	134,67	670	172,90	170,25
		690	124,64	175,33	780	201,29	198,20
		850	153,55	215,98	800	206,45	203,28
		1000	180,64	254,10	827	213,42	210,14
28	267,72	420	84,97	171,14	420	121,39	171,14
		570	115,32	232,27	720	208,10	293,39
		720	145,67	293,39	810	234,11	330,06
		870	176,02	354,51	900	260,12	366,73
		1000	202,32	407,48	926	267,72	377,44
32	349,67	480	110,99	255,47	480	158,55	255,47
		610	141,04	324,66	610	201,49	324,66
		740	171,10	393,84	740	244,43	393,84
		870	201,16	463,03	870	287,37	463,03
		1000	231,22	532,22	1000	330,32	532,22

The given values are valid for good bond condition according to EN 1992-1-1. For all other bond condition the values for tension load shall be multiplied by 0,7. The mortar volume V can be calculated using the equation: $V = l_{bd} \cdot \pi \cdot (d_o^2 - d^2) / (4 \cdot 0,85)$ with the nominal hole diameter.

**Injection system 680 ANKER KLEBER
for rebar connections**

Design values for overlap joint connections

Annex C3
of European
Technical Assessment
ETA-17/0680